

Productierijp patroon & Naadbreedtes

Naam:

Codes van patronen

 Klant: Emma
klantnr: 1234
model: blouse
materiaal: zijde
1x 

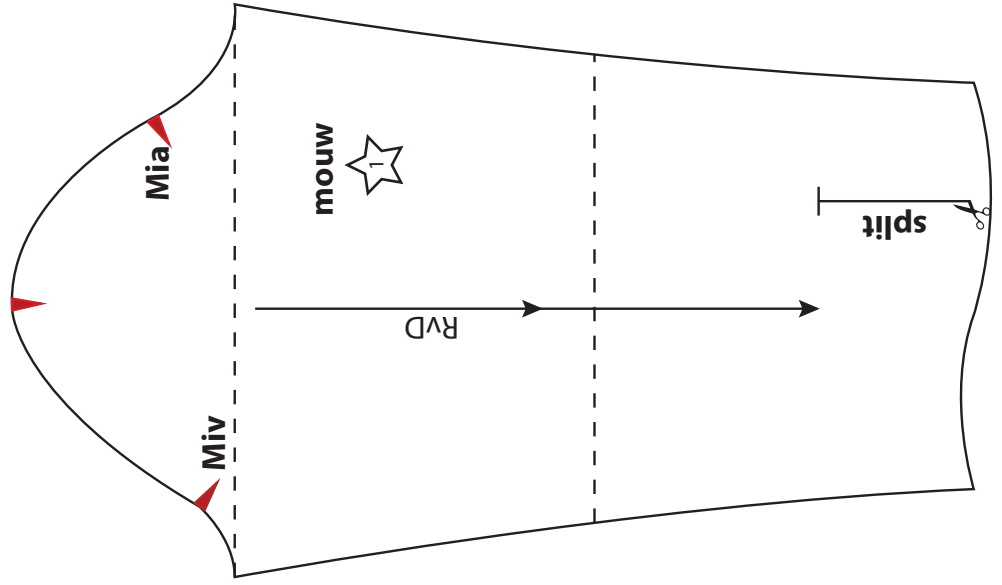
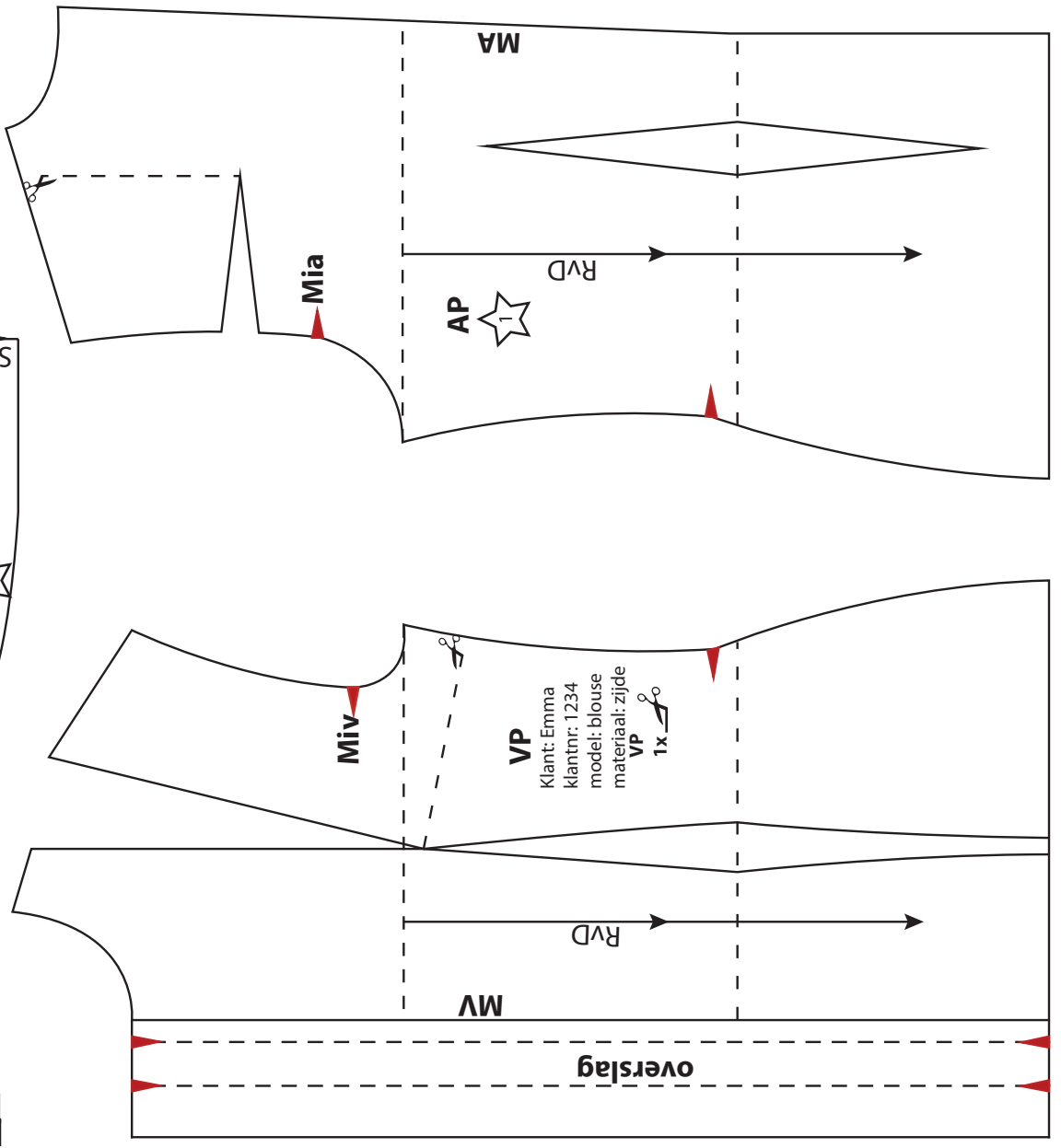
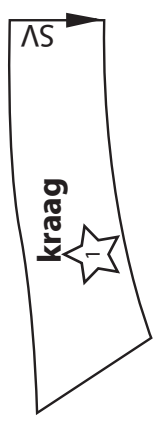

Naadbreedtes & zomen

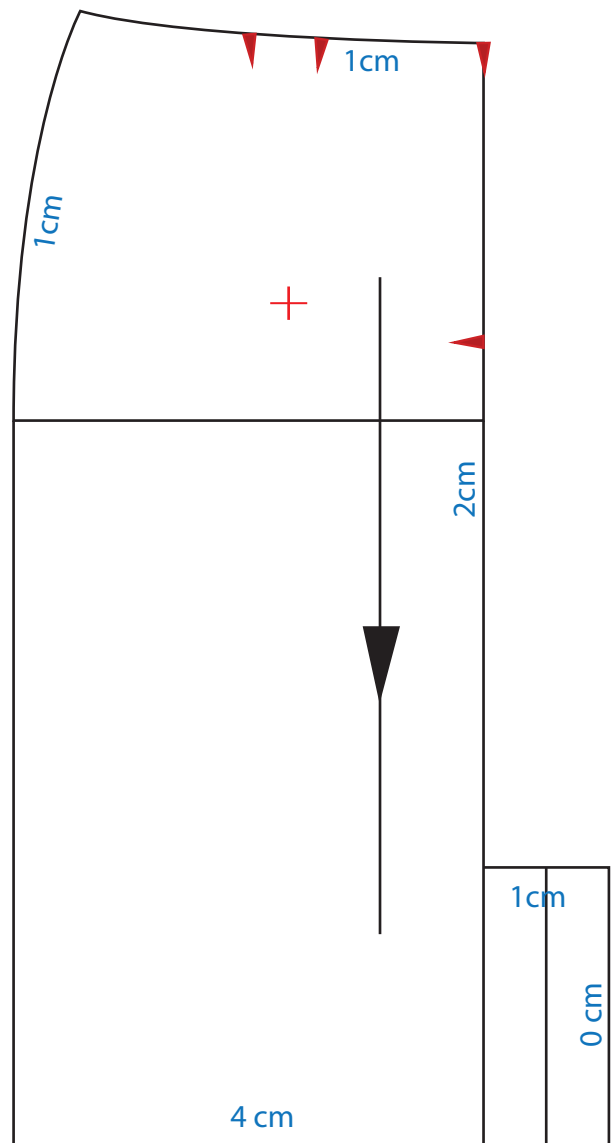
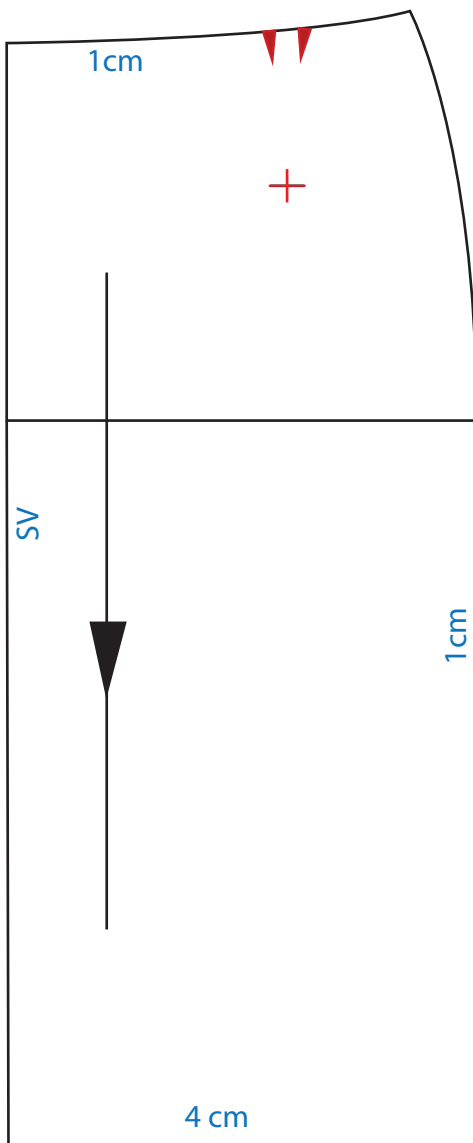
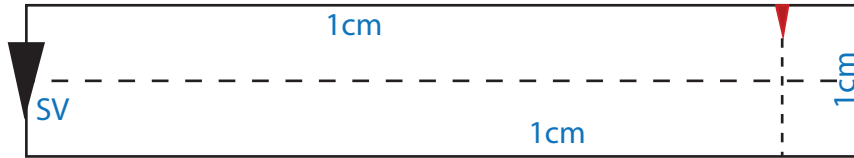

Naadbreedtes & zomen

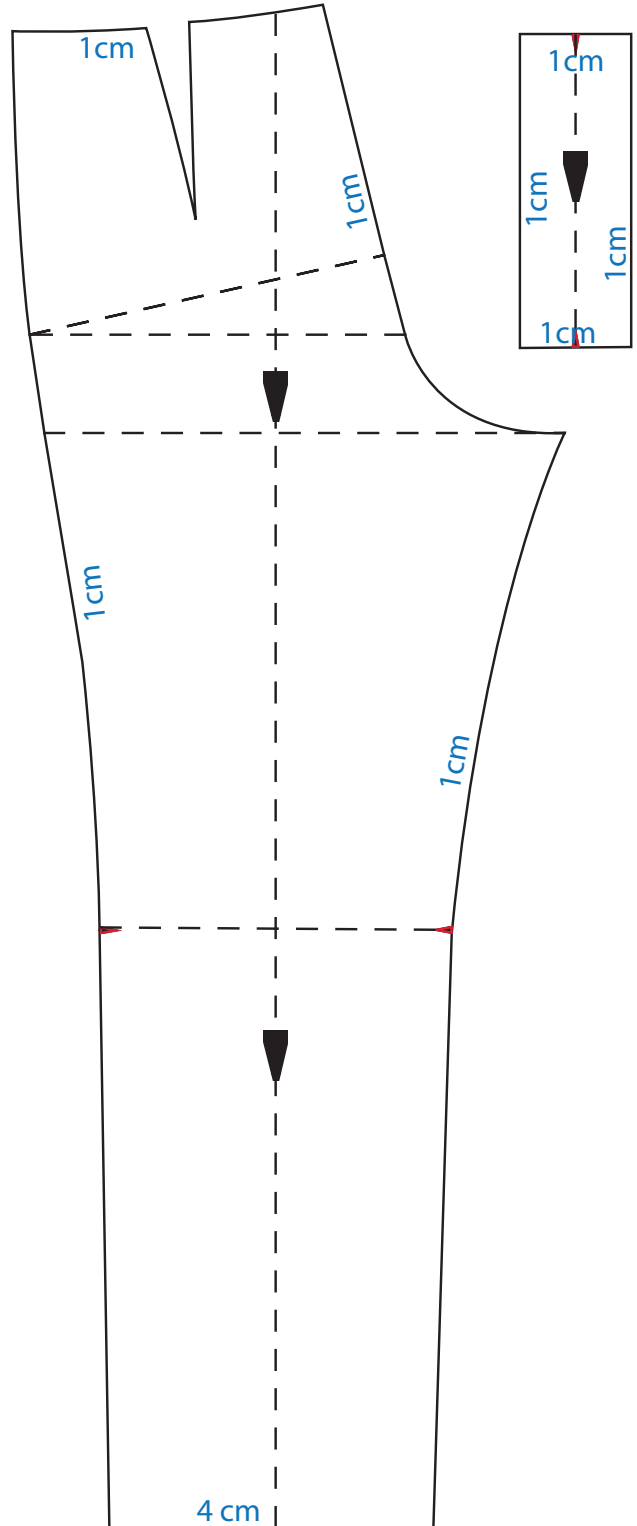
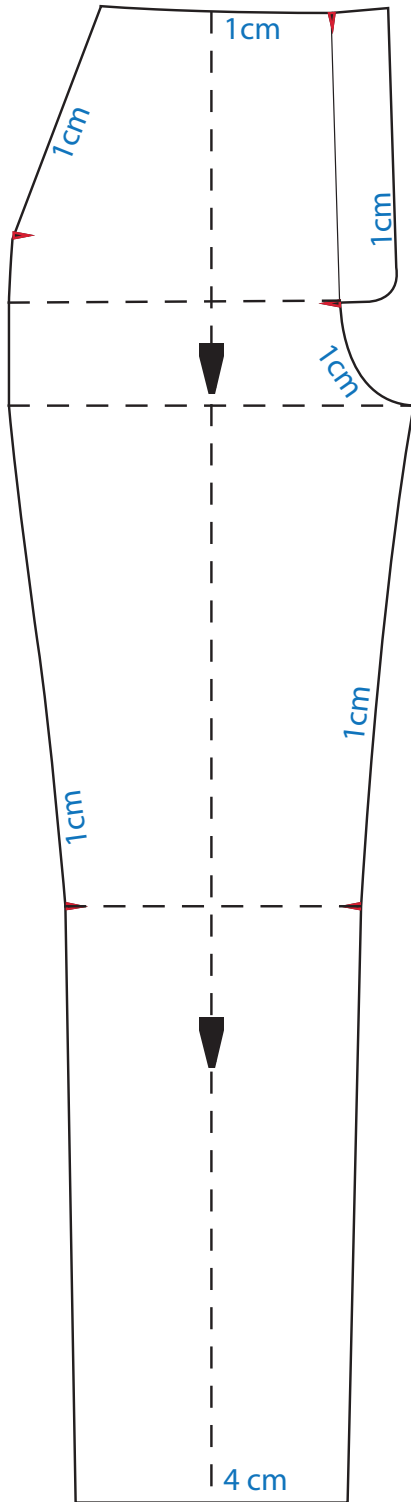
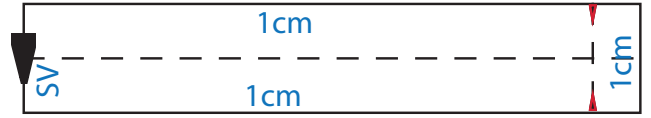
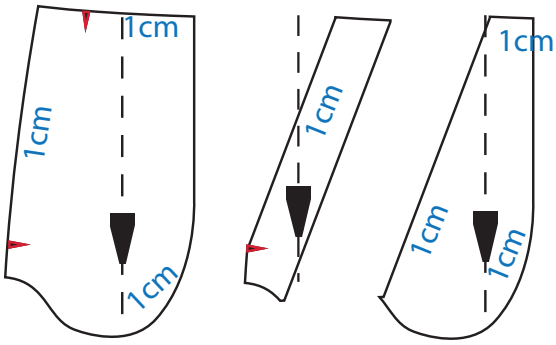

Naadbreedtes & zomen

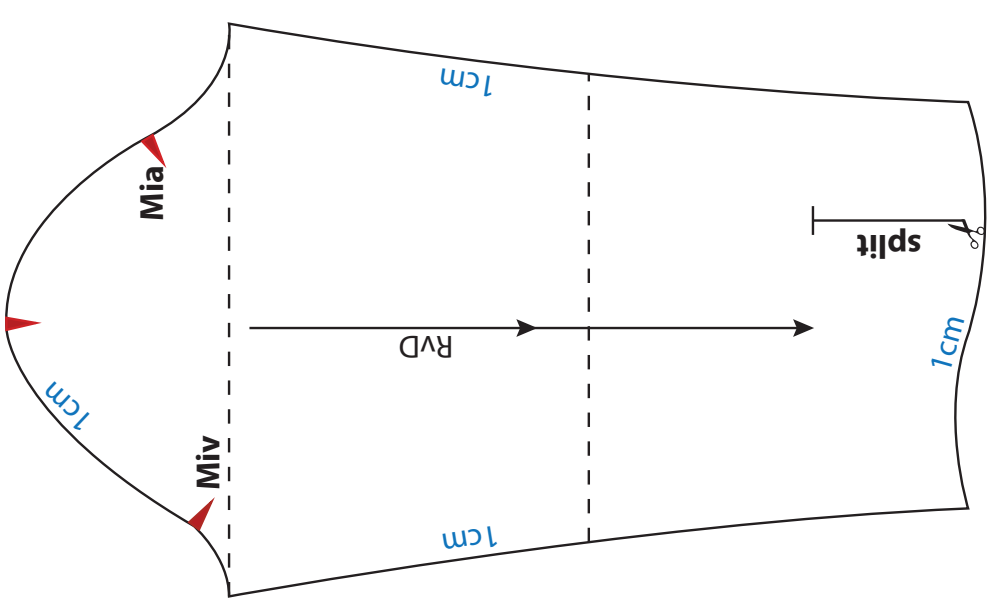
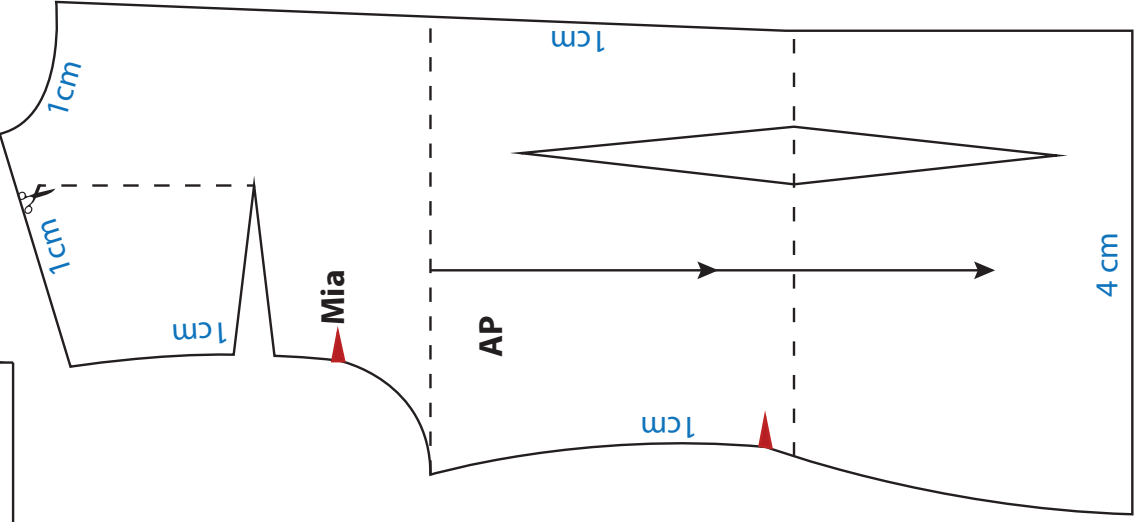
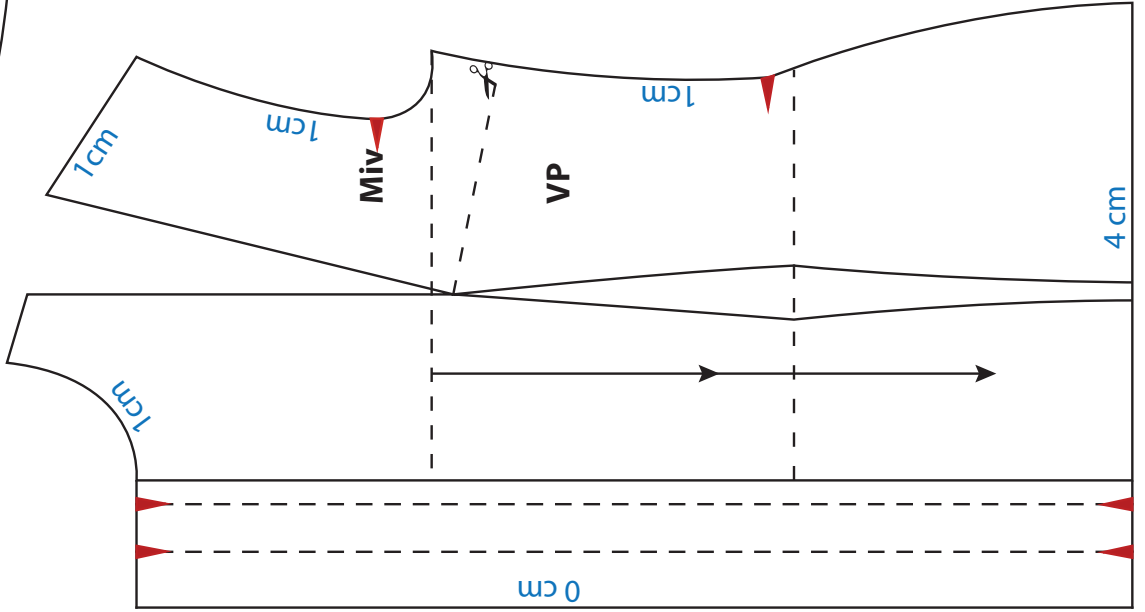
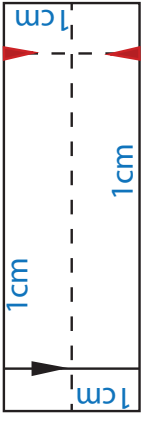
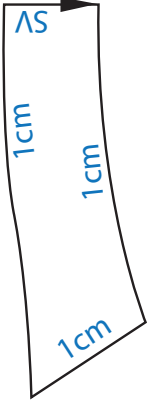

Naadbreedtes & zomen

